

REVISIONS

REV#	DESCRIPTION	APPV.	REV DATE

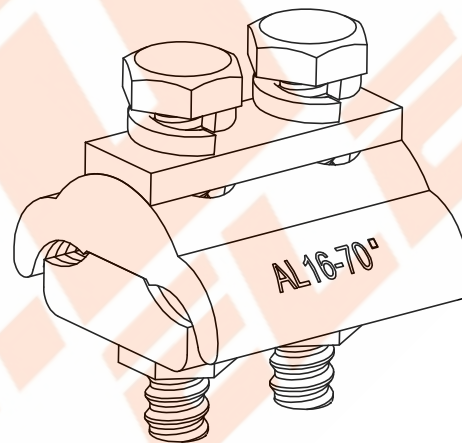
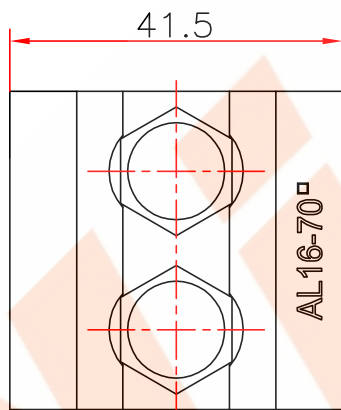
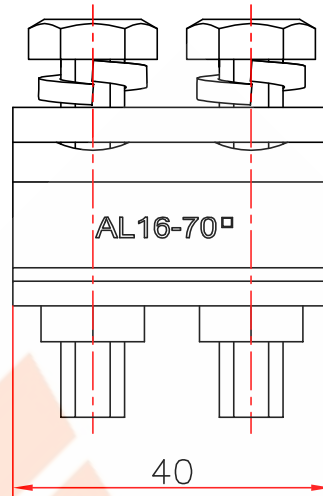
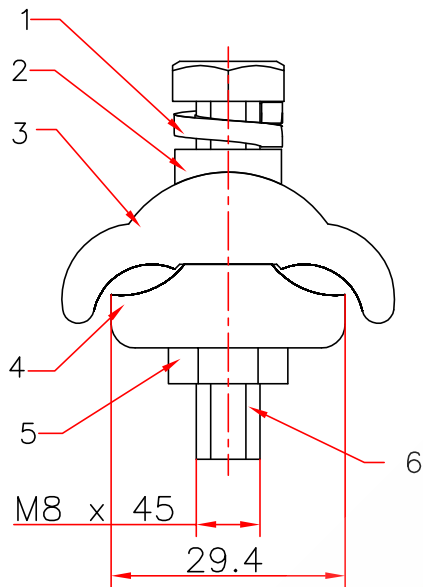

AL wire cross section : 16–70 mm²

6	BOLT	MILD STEEL		2
5	NUT	MILD STEEL		2
4	BOTTOM BODY	ALUMINIUM ALLOY	NATURAL & BRIGHT	1
3	TOP BODY	ALUMINIUM ALLOY	NATURAL & BRIGHT	1
2	WASHER	ALUMINIUM ALLOY	NATURAL & BRIGHT	1
1	ROUDE SPRING WASHER	MILD STEEL		2
SR. NO	ITEM DESCRIPTION	MATERIAL	FINISH	QTY



N.I.U ELECTRIC GROUP CO.,LTD
 Beibaixiang Zone, Yueqing City,
 Zhejiang Province, China-325604
 Tel:+86-577-62622652
 E-mail:sales@niuelec.com

DRAWN:David

DRG No:NIU#
 APG-B AL16-70

CHECKED: